



*Continuous Forms Processing  
& Mailing Equipment*



## **SPEDO 2600 PINLESS FORMS CUTTER SPARE PARTS LIST**

**SPEDO UK LTD, 76 WOOLMER WAY, BORDON, HAMPSHIRE GU35 9QF, UK  
TEL: +44 (0) 1420 487442 • FAX: +44 (0) 1420 477827  
E-MAIL: [spedo@spedouk.com](mailto:spedo@spedouk.com) • WEBSITE: [www.spedouk.com](http://www.spedouk.com)**

INDEX

|                                                      |              |
|------------------------------------------------------|--------------|
| <b>ELECTRICAL PARTS</b>                              | PAGES 3 – 5  |
| OPERATOR PANEL.....                                  | 4            |
| CABLES.....                                          | 5            |
| <b>MECHANICAL PARTS</b>                              | PAGES 6 – 32 |
| DRIVER COMPARTMENT.....                              | 6            |
| BLADE DRIVE ASSEMBLY.....                            | 6            |
| PAPER TRANSPORT COMPARTMENT.....                     | 7            |
| SAFETY COVER ASSEMBLY.....                           | 8            |
| EDGE TRIMMER ASSEMBLY.....                           | 9 – 11       |
| CENTRE CUTTER ASSEMBLY.....                          | 12 – 14      |
| PAPER TRANSPORT ASSEMBLY.....                        | 15 – 18      |
| INFEED BRUSH ASSEMBLY.....                           | 19           |
| UPPER LINEAR GUIDE ASSEMBLY & LOWER PAPER GUIDE..... | 19           |
| INDEX WHEEL ASSEMBLY.....                            | 20           |
| FEED MOTOR MOUNT ASSEMBLY.....                       | 20           |
| INFEED GUIDE ASSEMBLY.....                           | 20 - 21      |
| PRESSURE HEAD ASSEMBLY.....                          | 21 – 23      |
| DRIVE ROLLER ASSEMBLY.....                           | 23 – 24      |
| ANTI-LIFT BAR ASSEMBLY.....                          | 24           |
| SENSOR MOUNT ASSEMBLY.....                           | 25           |
| MARGIN TRIM BURSTER [OPTIONAL].....                  | 25 – 26      |
| BEARING PLATE COMPARTMENT.....                       | 27           |
| PAPER OUTPUT.....                                    | 28           |
| GANTRY ASSEMBLY.....                                 | 28           |
| BLADE ASSEMBLY.....                                  | 29 – 30      |
| STACK TRAY.....                                      | 31           |
| KICKOUT ROLLER.....                                  | 31           |
| AIR BLAST PUMP.....                                  | 32           |

ELECTRICAL PARTS

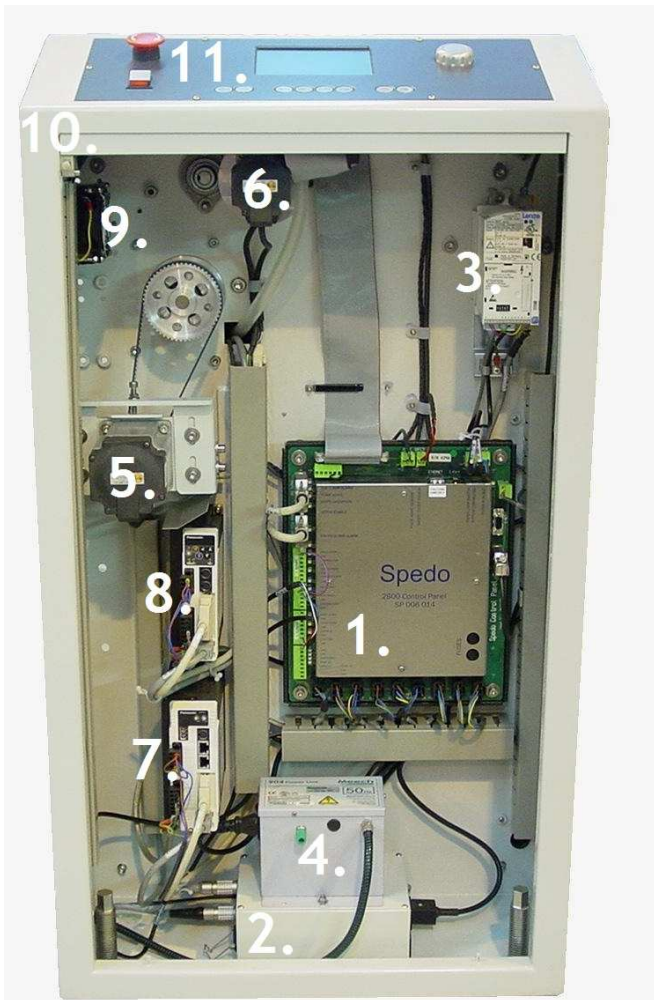

SP 006 849  
SENSOR, PRINT MARK



SP 006 030  
MOTOR ASSEMBLY



SP 005 447  
RUN-OUT SWITCH  
ASSEMBLY



SP 006 852  
BAR, ANTI-STATIC  
SHOCKLESS



1. SP 006 844  
CONTROL PANEL  
COMPLETE



2. SP 006 478  
POWER DISTRIBUTION  
BOX



3. SP 006 029  
INVERTER ASSEMBLY



4. SP 006 851  
POWER UNIT, ANTI-  
STATIC



5. SP 006 846  
BLADE SERVO  
MOTOR



6. SP 006 016  
PINFEED SERVO  
MOTOR



7. SP 006 848  
BLADE SERVO DRIVER



8. SP 006 015  
PINFEED SERVO  
DRIVER



9. SP 006 476  
FAN ASSEMBLY



10. SP 004 460  
DOOR/SAFETY  
SWITCH

11. SP 006 845 - 2600 OPERATOR PANEL COMPLETE

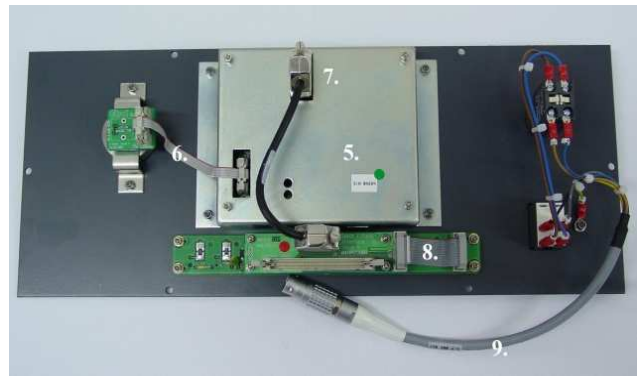

1. SP 005 653  
EMERGENCY STOP  
SWITCH



2. SP 005 652  
MAINS ON/OFF  
SWITCH



3. SP 006 034  
OPERATOR PANEL  
KEYPAD



4. SP 006 334  
DIGITAL SPEED POT  
ASSEMBLY



SP 006 337  
E-WHEEL [SPARE PART  
FOR SP 006 334]

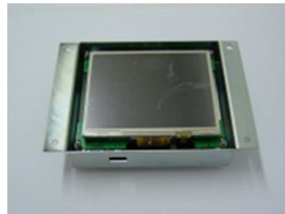

5. SP 006 419  
ENHANCED OPERATOR  
PCB ASSEMBLY



6. SP 006 417  
SPEED CONTROL  
CABLE



7. SP 006 413  
LCD COMMS CABLE

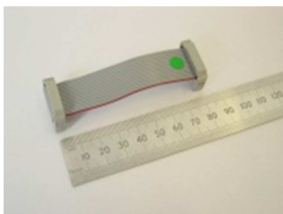

8. SP 006 035  
OPERATOR SWITCH  
RIBBON CABLE



9. SP 006 037  
OPERATOR ON/OFF  
CABLE

2600 CABLES

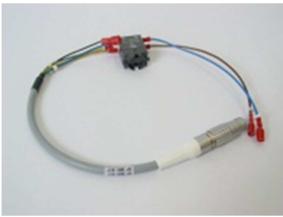

SP 006 037  
OPERATOR PANEL ON/OFF  
CABLE



SP 004 547  
KNIFE SENSOR CABLE C/W  
SENSOR



SP 006 026  
MAINS SAFETY COVER  
SWITCH CABLE



SP 006 084  
INVERTER POWER CABLE



SP 006 470  
PAPER RUN-OUT CABLE



SP006 086  
PIN FEED SERVO POWER  
CABLE



SP 006 085  
BLADE SERVO POWER CABLE



SP 006 062  
MAINS POWER CABLE



SP 006 020  
PIN FEED MOTOR CABLE



SP 006 021  
PIN FEED BRAKE CABLE



SP 006 018  
PIN FEED I/O CABLE



SP 006 024  
BLADE MOTOR CABLE



SP 006 023  
BLADE ENCODER CABLE



SP 006 022  
BLADE I/O CABLE



SP 006 019  
PIN FEED ENCODER CABLE



SP 004 546  
OPERATOR PANEL RIBBON  
CABLE



SP 006 471  
SAFETY COVER CABLE



SP 004 541  
LOOP CONTROL CABLE



SP 006 850  
PRINT MARK SENSOR CABLE

MECHANICAL PARTS

DRIVER COMPARTMENT

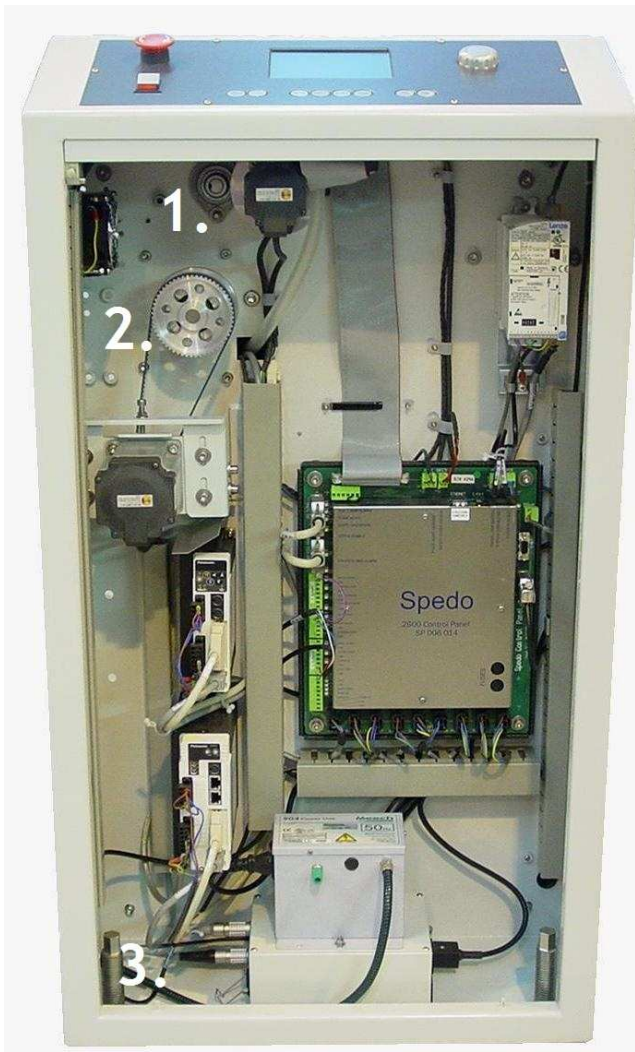

1. SP 002 133  
BEARING, E/T SHAFT



2. SP 006 879  
SHORT STROKE BLADE  
DRIVE ASSEMBLY

\* BLADE DRIVE ASSEMBLY SPARES LISTED BELOW \*



3. SP 006 826  
FOOT ASSEMBLY



SP 004 796  
DOOR LOCK UNIT [NOT  
SHOWN]

BLADE DRIVE ASSEMBLY SPARE PARTS



SP 006 876  
PULLEY, 55T, BLADE  
TIMING



SP 004 538  
PULLEY, 20T, BLADE DRIVE  
TIMING

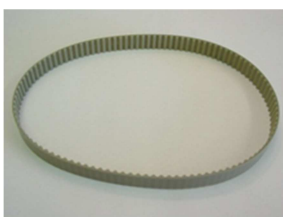

SP 004 805  
BELT, BLADE DRIVE



SP 004 510  
CRANK, BLADE DRIVE



SP 004 832  
SPACER, BLADE CRANK



SP 004 812  
CIRCLIP, EXTERNAL, 20MM



SP 003 389  
CIRCLIP, INTERNAL, 42MM



SP 004 762  
BEARING

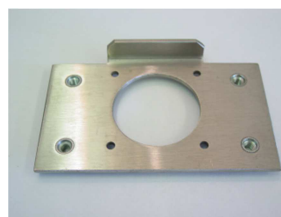

SP 006 937  
PLATE, MOTOR MOUNTING

PAPER TRANSPORT COMPARTMENT

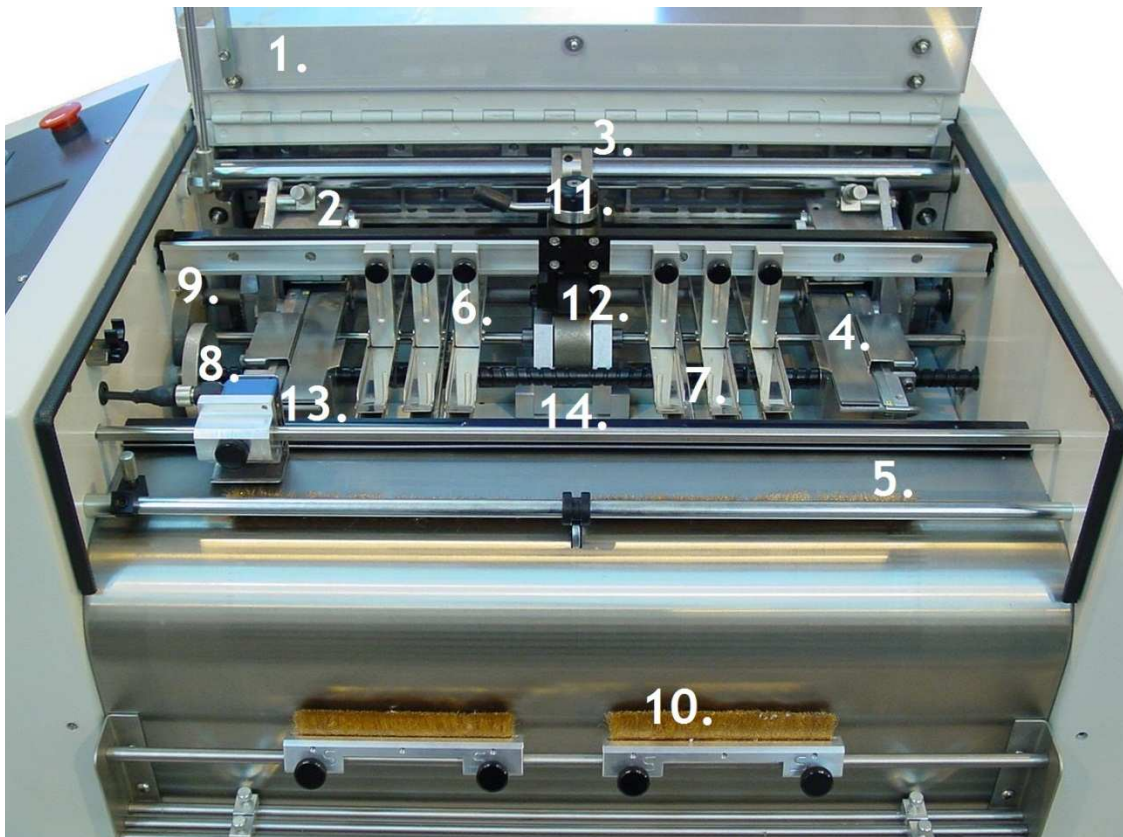

- |          |                                                   |
|----------|---------------------------------------------------|
| 1.       | SAFETY COVER ASSEMBLY                             |
| 2.       | EDGE TRIMMER ASSEMBLY                             |
| 3.       | CENTRE CUTTER ASSEMBLY                            |
| 4.       | PAPER TRANSPORT ASSEMBLY                          |
| 5.       | INFEEED BRUSH ASSEMBLY                            |
| 6.       | UPPER LINEAR GUIDE ASSEMBLY                       |
| 7.       | PAPER GUIDE, LOWER                                |
| 8.       | INDEX WHEEL ASSEMBLY                              |
| 9.       | FEED MOTOR MOUNT ASSEMBLY                         |
| 10.      | INFEEED GUIDE ASSEMBLY                            |
| 11.      | PRESSURE HEAD ASSEMBLY                            |
| 12.      | DRIVE ROLLER ASSEMBLY                             |
| 13.      | SENSOR MOUNT ASSEMBLY                             |
| 14.      | ANTI-LIFT BAR ASSEMBLY                            |
| OPTIONAL | MARGIN TRIM BURSTER ASSEMBLY                      |
| OPTIONAL | GUTTER CUT KIT *PLEASE CONTACT SPEDO FOR DETAILS* |

SAFETY COVER ASSEMBLY SPARE PARTS

SP 000 177 SAFETY COVER

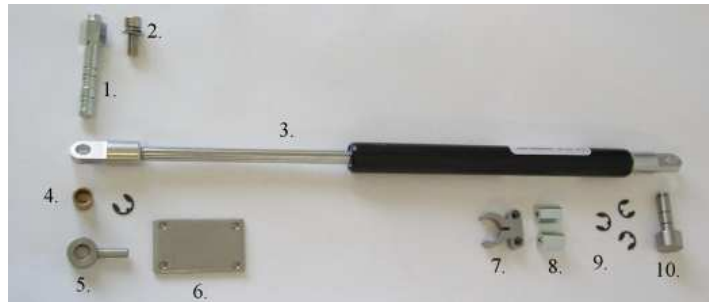

1. SP 000 385  
SPINDLE, SAFETY COVER



2. SP 000 559  
SCREW, M6 x 12MM,  
SOCKET CAP



3. SP 000 117  
GAS DAMPER



4. SP 000 682  
BUSH, OILITE



5. SP 005 118  
SET RING, 8 x 16 x 8MM



6. SP 001 811  
PLATE, SAFETY COVER  
SWITCH



7. SP 002 211  
CLAMP, GAS  
DAMPER

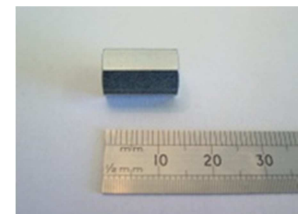

8. SP 001 210  
PILLAR, SAFETY  
COVER



9. SP 00 958  
CIRCLIP, 6MM, E-TYPE



10. SP 000 380  
BOLT, SAFETY COVER



1. SP 000 519  
STRIP, EDGE  
PROTECTION



2. SP 000 760  
ANGLE, SAFETY  
COVER SUPPORT, RH



SP 000 761  
ANGLE, SAFETY  
COVER SUPPORT, LH



3. SP 002 040  
BAR, GAS DAMPER  
MOUNT



4. SP 004 710  
HINGE, SAFETY  
COVER



EDGE TRIMMER ASSEMBLY SPARE PARTS



SP 006 911  
EDGE TRIMMER COMPLETE,  
LH



SP 006 910  
EDGE TRIMMER COMPLETE,  
RH

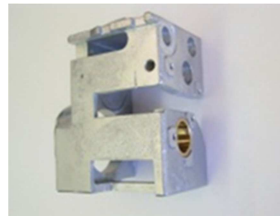

SP 006 909  
E/T HOUSING, LH



SP 006 908  
E/T HOUSING, RH



SP 006 668  
MTB GUIDE, LH



SP 006 669  
MTB GUIDE, RH



SP 006 905  
DEFLECTOR PAPER GUIDE,  
LH



SP 006 904  
DEFLECTOR PAPER GUIDE,  
RH



SP 005 241  
SHAFT, E/T DRIVE

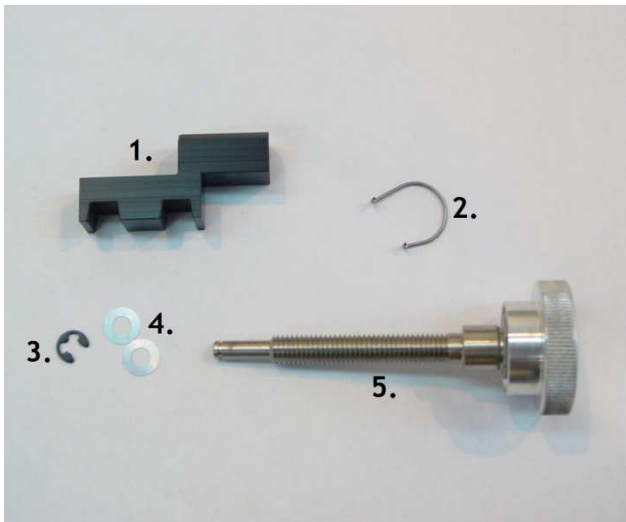

1. SP 006 903  
DETENT



2. SP 001 104  
SPRING, INDEXING, E/T  
HOUSING



3. SP 001 924  
CIRCLIP, 4MM, E-TYPE

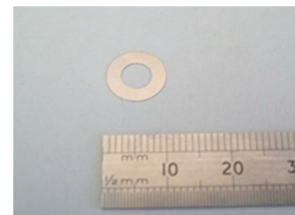

4. SP 003 426  
SHIM, 5.15 x 10 x 0.1MM



5. SP 000 382  
SPINDLE, E/T  
HOUSING

EDGE TRIMMER ASSEMBLY SPARE PARTS

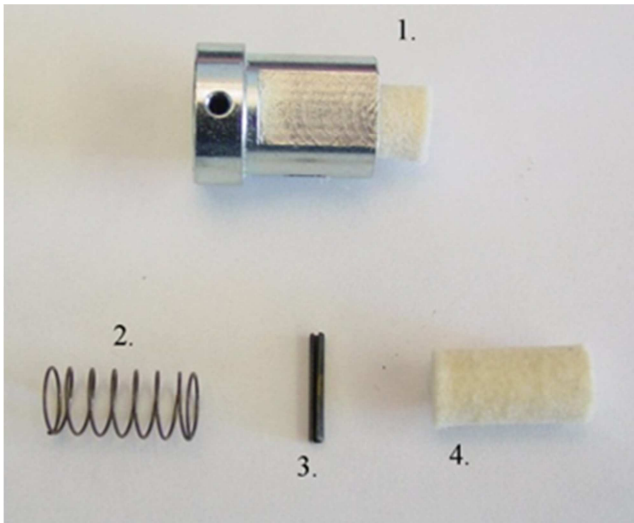

1. SP 000 164  
LUBRICATION  
COMPLETE

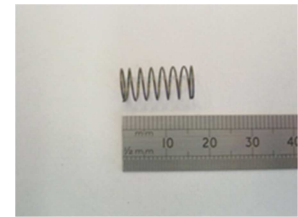

2. SP 003 433  
SPRING



3. SP 001 478  
ROLL PIN



4. SP 003 118  
FELT WICK

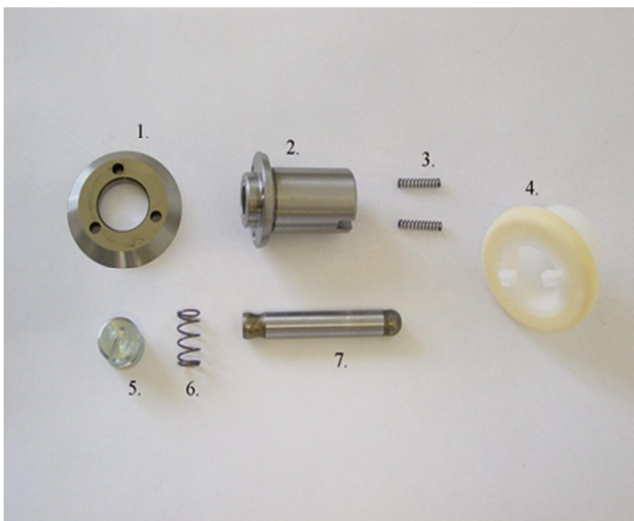

1. SP 000 063  
BLADE, 45°



2. SP 004 853  
E/T TOP HUB COMPLETE



3. SP 000 381  
SPRING, E/T TOP HUB



4. SP 006 420  
FRICTION HUB



5. SP 003 021  
BUSH, ECCENTRIC



6. SP 001 828  
SPRING, E/T HOUSING  
SPINDLE



7. SP 003 421  
AXLE, SHAFT E/T

EDGE TRIMMER ASSEMBLY SPARE PARTS

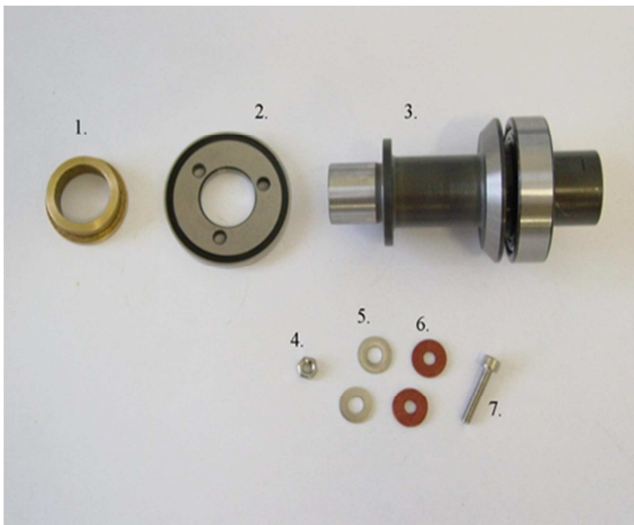

1. SP 000 248  
BUSH, FLANGED



2. SP 000 064  
BLADE, 90°



3. SP 004 747  
HUB, LOWER, C/W  
BEARING



SP 001 829  
HUB, LOWER W/O  
BEARING

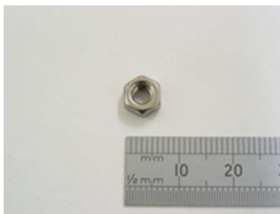

4. SP 000 953  
NUT, M4



5. SP 000 711  
WASHER, M5



6. SP 000 796  
WASHER, FIBRE



7. SP 000 517  
SCREW, M4 x 20MM

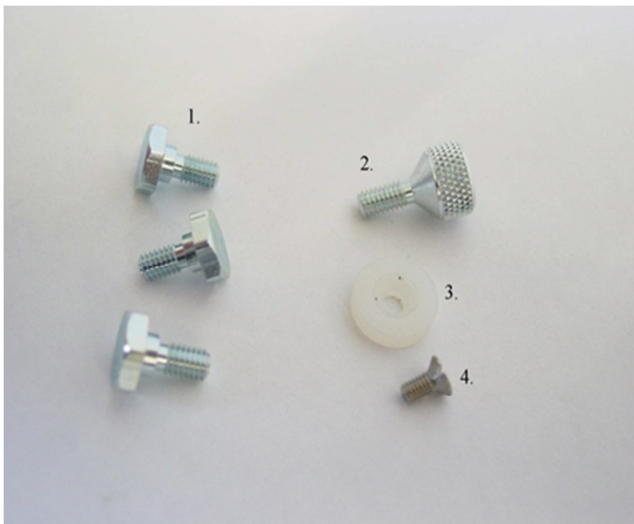

1. SP 001 158  
SCREW, M4 x 8.7MM,  
HEX



2. SP 000 359  
WASHER, NYLON



3. SP 004 816  
SCREW, M3 x 6MM,  
COUNTERSUNK



4. SP 000 356  
SCREW, KNURLED,  
E/T HOUSING

CENTRE CUTTER ASSEMBLY SPARE PARTS



SP 003 108  
CENTRE CUTTER ASSEMBLY COMPLETE

SP 003 086  
BEARING ARM ASSEMBLY

SP 002 043  
LOWER HUB C/W BLADE ASSEMBLY

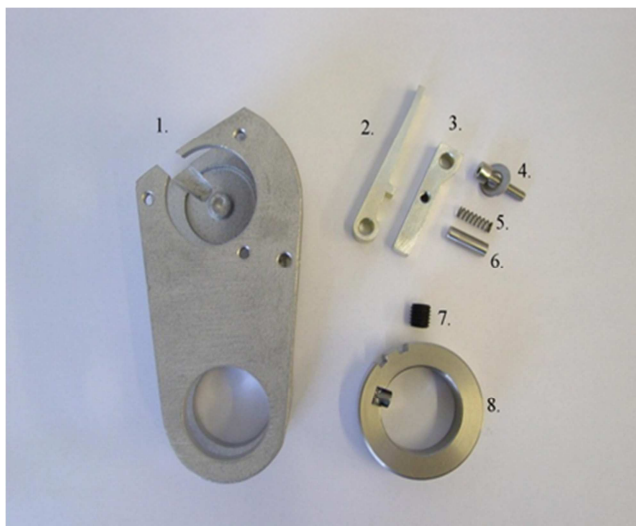

1. SP 006 038  
BEARING ARM



2. SP 003 041  
LEVER, LOCKING



3. SP 003 031  
MOUNT, LOCKING  
LEVER



4. SP 000 851  
SCREW, M4 X 16MM  
[ WITH WASHER SP 000 711 ]



5. SP 000 240  
SPRING, LOCKING  
LEVER



6. SP 004 847  
PIN, HINGE



7. SP 000 892  
SCREW, M8 X 8MM,  
GRUB



8. SP 001 866  
RING, CLAMPING

CENTRE CUTTER ASSEMBLY SPARE PARTS

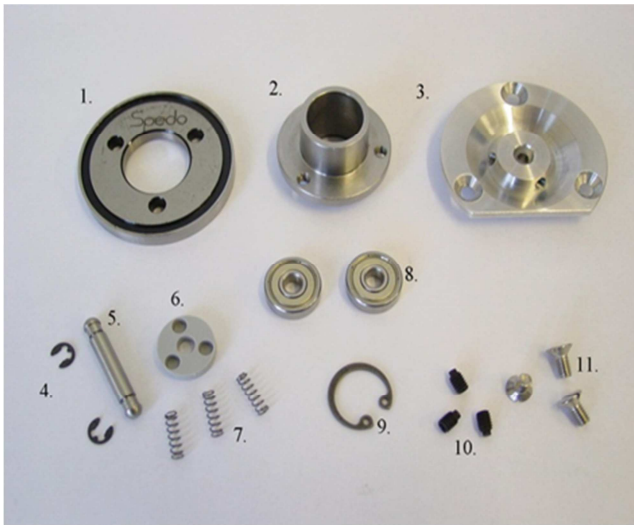

1. SP 000 064  
BLADE, 90°



2. SP 003 229  
HUB, CENTRE CUTTER  
TOP

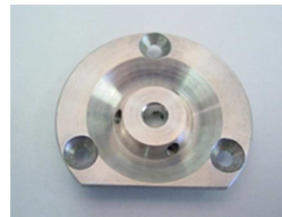

3. SP 003 002  
PLATE, CENTRE  
CUTTER



4. SP 002 022  
CIRCLIP, 4MM, E-TYPE



5. SP 003 075  
AXLE, CENTRE CUTTER  
TOP HUB



6. SP 003 062  
PLATE, SPRING



7. SP 002 228  
SPRING, SPRING PLATE



8. SP 004 615  
BEARING, CENTRE  
CUTTER TOP HUB



9. SP 004 838  
CIRCLIP, 16MM,  
INTERNAL



10. SP 000 854  
SCREW, M4 X 6MM,  
GRUB



11. SP 000 412  
SCREW, M4 X 8MM,  
COUNTERSUNK

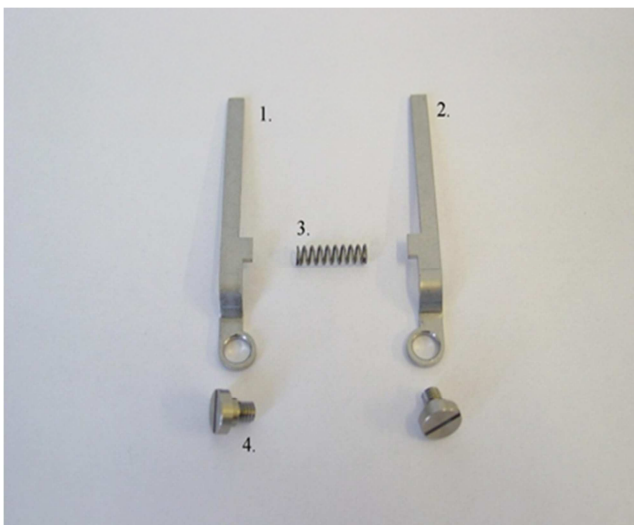

1. SP 004 845  
LEVER, SIDE  
ADJUSTING, LH



2. SP 004 475  
LEVER, SIDE  
ADJUSTING, RH



3. SP 000 330  
SPRING, PRESSURE



4. SP 004 712  
SCREW, SHOULDERED

CENTRE CUTTER ASSEMBLY SPARE PARTS

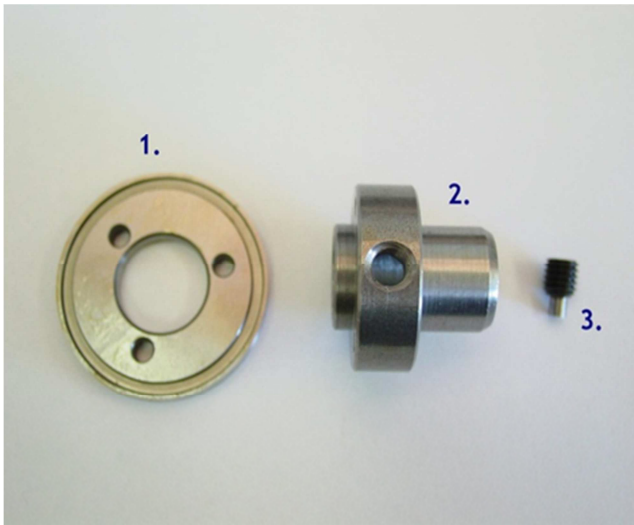

1. SP 000 064  
BLADE, 90°



2. SP 001 913  
HUB, LOWER



3. SP 004 631  
SCREW, CENTRE  
CUTTER

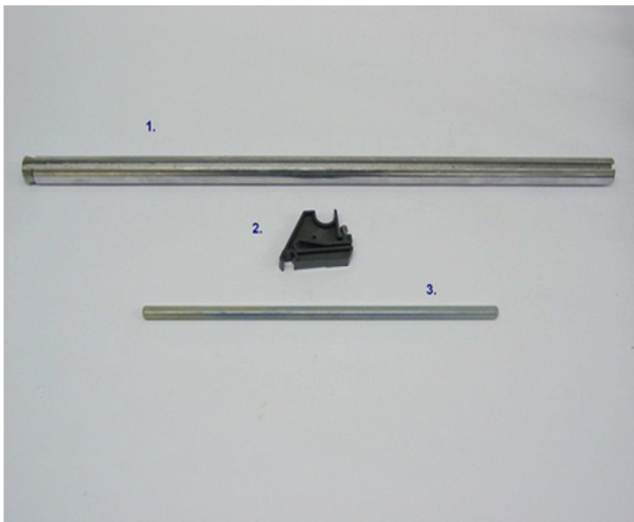

1. SP 001 851  
BAR, CENTRE CUTTER  
ARM MOUNT



2. SP 000 389  
BRIDGE, CENTRE  
CUTTER



3. SP 000 700  
BAR, CENTRE CUTTER  
BRIDGE SUPPORT

PAPER TRANSPORT ASSEMBLY SPARE PARTS

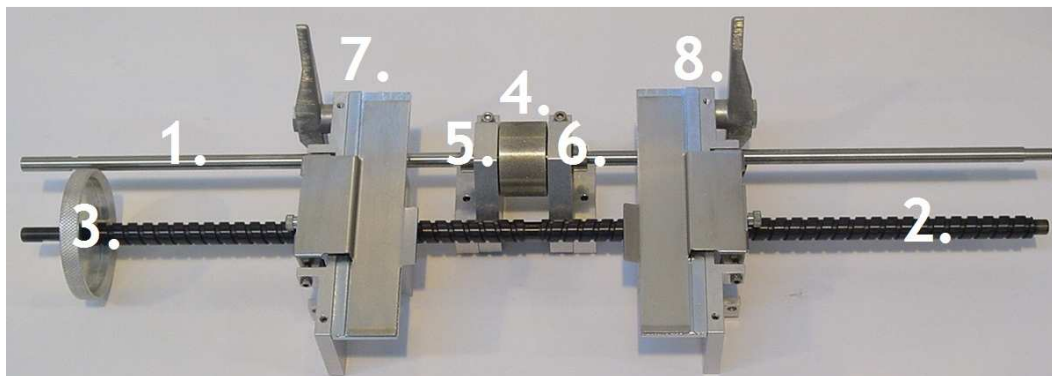

1. SP 006 941  
SHAFT, DRIVE ROLLER



2. SP 004 657  
SHAFT, SCROLL



3. SP 006 942  
HANDWHEEL, SIDE  
ADJUST



4. SP 006 869  
DRIVE ROLLER  
ASSEMBLY



5. SP 006 871  
DRIVE ROLLER MOUNT  
ASSEMBLY, LH



6. SP 006 870  
DRIVE ROLLER MOUNT  
ASSEMBLY RH



7. SP 006 936  
FORM GUIDE  
ASSEMBLY, LH



8. SP 006 935  
FORM GUIDE  
ASSEMBLY, RH

\* DRIVE ROLLER MOUNT ASSEMBLY SPARES LISTED BELOW \*

\* FORM GUIDE ASSEMBLY SPARES LISTED BELOW \*

DRIVE ROLLER MOUNT ASSEMBLY SPARE PARTS

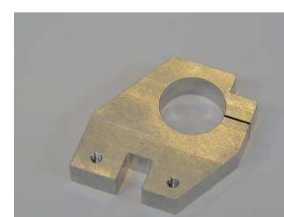
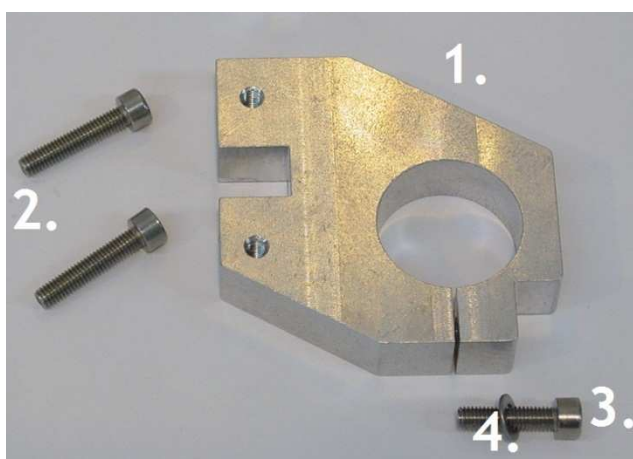

1. SP 006 867  
CLAMP, BEARING



2. SP 000 864  
SCREW, M5 x 25,  
SOCKET HEAD



3. SP 000 447  
SCREW, M5 x 20MM,  
SOCKET CAP



4. SP 000 575  
WASHER, M5  
STANDARD

DRIVE ROLLER MOUNT ASSEMBLY SPARE PARTS

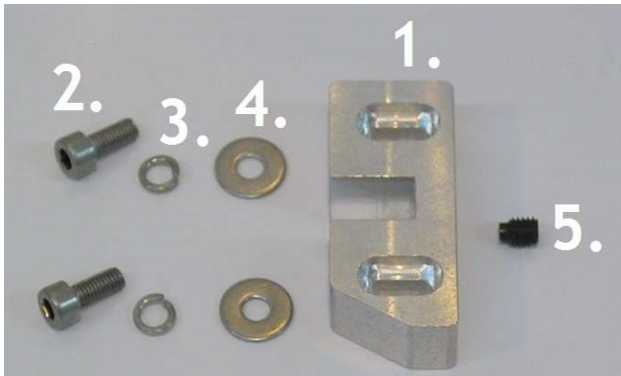

1. SP 006 868  
MOUNT, BEARING  
CLAMP, LH



SP 006 866  
MOUNT, BEARING  
CLAMP, RH



2. SP 000 454  
SCREW, M5 X 12,  
SOCKET HEAD



3. SP 005 080  
WASHER, M5,  
SPRING



4. SP 005 081  
WASHER, M5, PLAIN



5. SP 000 889  
SCREW, M6 X 8, DOG  
POINT

FORM GUIDE ASSEMBLY SPARE PARTS

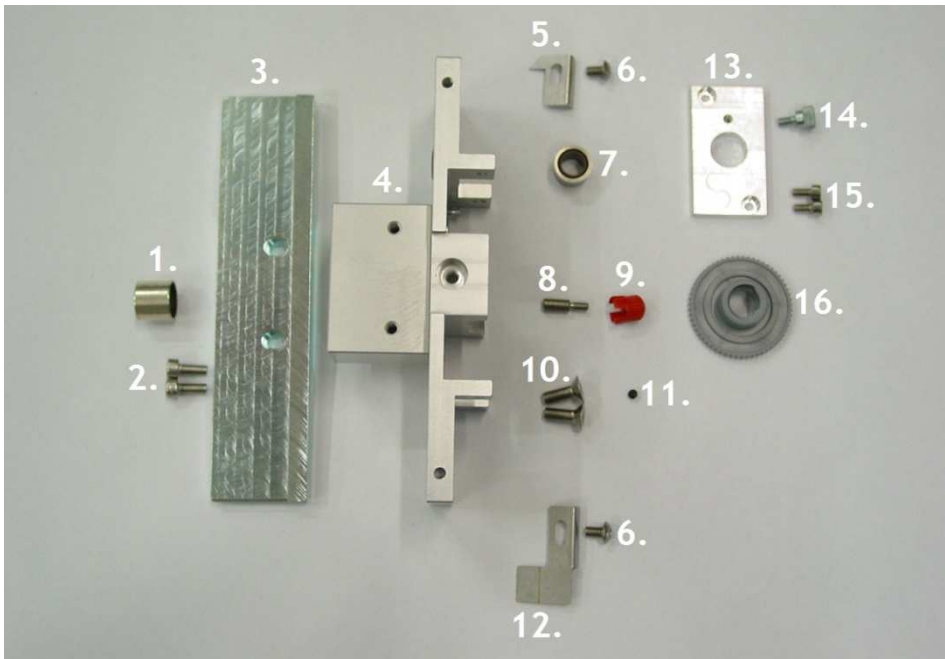

1. SP 005 825  
BUSH



2. SP 001 009  
SCREW, M5 X 16MM  
SOCKET CAP



3. SP 006 931  
FORM GUIDE PLATE,  
LH



SP 006 930  
FORM GUIDE PLATE,  
RH



4. SP 006 862  
FORM GUIDE MOUNT,  
LH



SP 006 861  
FORM GUIDE MOUNT,  
RH



FORM GUIDE ASSEMBLY SPARE PARTS

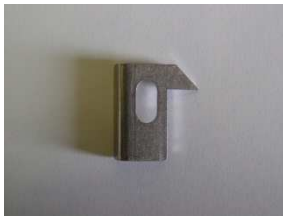

5. SP 007 078  
FORM INFEEED  
MARKER, LH



SP 007 076  
FORM INFEEED  
MARKER, RH

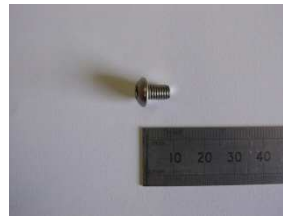

6. SP 001 665  
SCREW, M5 X 8MM,  
BUTTON SOCKET



7. SP 006 858  
BUSH, 10MM SELF  
ALIGNING



8. SP 003 057  
PIN, FEED UNIT  
HEIGHT ADJUSTING



9. SP 005 052  
NUT, HEIGHT  
ADJUSTING



10. SP 000 197  
SCREW, M6 X 16MM,  
COUNTERSUNK



11. SP 000 047  
SCREW, M4 X 4MM,  
GRUB



12. SP 007 082  
FORM INFEEED  
DEFLECTOR, LH



SP 007 080  
FORM INFEEED  
DEFLECTOR, RH



13. SP 000 165  
PLATE, FEED UNIT  
LOCKING



14. SP 001 965  
SCREW, KNURLED



15. SP 000 782  
SCREW, M4 X 8,  
SOCKET CAP



16. SP 005 054  
NUT, SPINDLE, LH



SP 005 055  
NUT, SPINDLE, RH

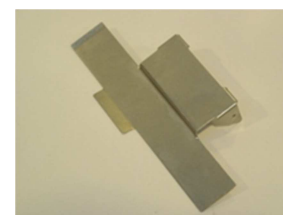
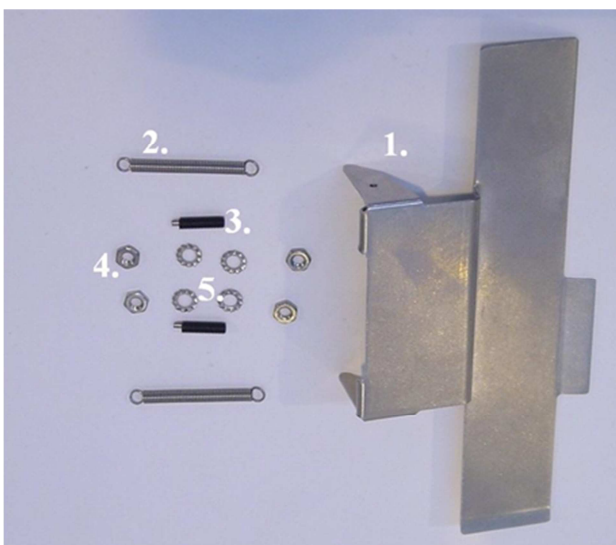

1. SP 006 934  
FLAP, FORM GUIDE  
UNIT, LH



SP 006 933  
FLAP, FORM GUIDE  
UNIT, RH



2. SP 000 170  
SPRING, INFEEED UNIT  
FLAP



3. SP 000 277  
PIN, THREADED, FEED  
UNIT FLAP

FORM GUIDE ASSEMBLY SPARE PARTS

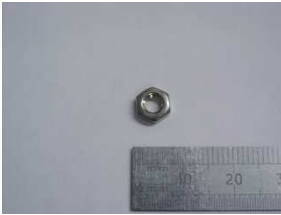

4. SP 000 643  
NUT, M4, HALF

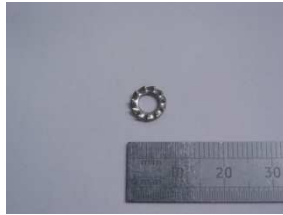

5. SP 000 784  
WASHER, M4, STAR

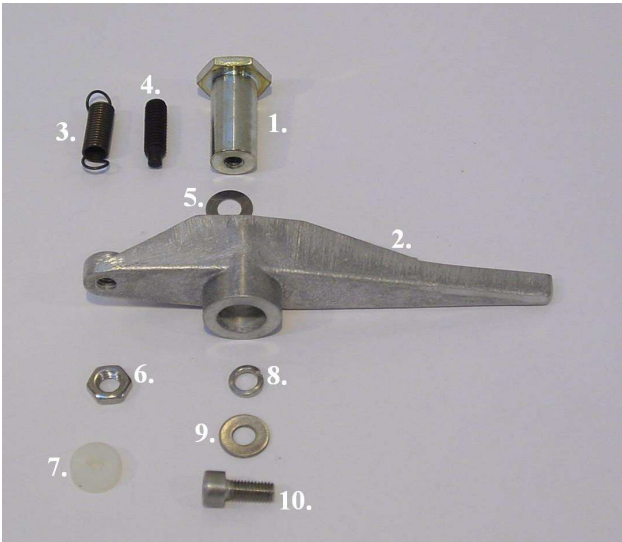

1. SP 003 024  
MOUNT, LEVER  
LOCKING



2. SP 004 684  
LEVER, LOCKING



3. SP 000 268  
SPRING, LOCKING  
LEVER



4. SP 003 056  
PIN, THREADED,  
LOCKING LEVER



5. SP 004 760  
SHIM

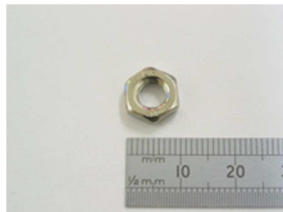

6. SP 000 555  
NUT, M6



7. SP 000 994  
SPACER, LOCKING  
LEVER SUPPORT



8. SP 005 080  
WASHER, M5, SPRING

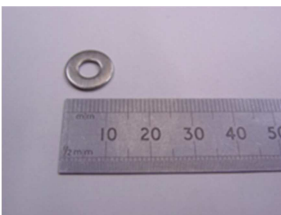

9. SP 000 711  
WASHER, M5, PLAIN



10. SP 001 009  
SCREW, M5 X 16MM,  
SOCKET HEAD

INFED BRUSH ASSEMBLY SPARE PARTS



SP 000 161  
INTAKE BRUSH, COMPLETE,  
STANDARD



SP 000 173  
BRUSH STRIP,  
REPLACEMENT, STANDARD



SP 002 186  
INTAKE BRUSH, COMPLETE,  
ANTI-STATIC



SP 000 673  
BRUSH STRIP, REPLACEMENT,  
ANTI-STATIC

INFED BRUSH ASSEMBLY SPARE PARTS



SP 000 672  
SPRING, INTAKE BRUSH



SP 003 040  
LEVER, INTAKE BRUSH



SP 003 071  
SCREW, KNURLED, INTAKE  
BRUSH



SP 001 053  
SPACER



SP 000 042  
MOUNT, INTAKE BRUSH



SP 003 023  
BUSH, INTAKE BRUSH

UPPER LINEAR GUIDE ASSEMBLY & LOWER PAPER GUIDE

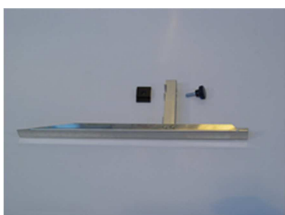

SP 006 929  
UPPER LINEAR GUIDE  
ASSEMBLY



SP 006 927  
SLIDE, LINEAR



SP 006 928  
KNOB, M5 x 15MM



SP 006 524  
PAPER GUIDE, LOWER

INDEX WHEEL ASSEMBLY SPARE PARTS

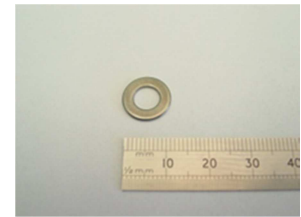
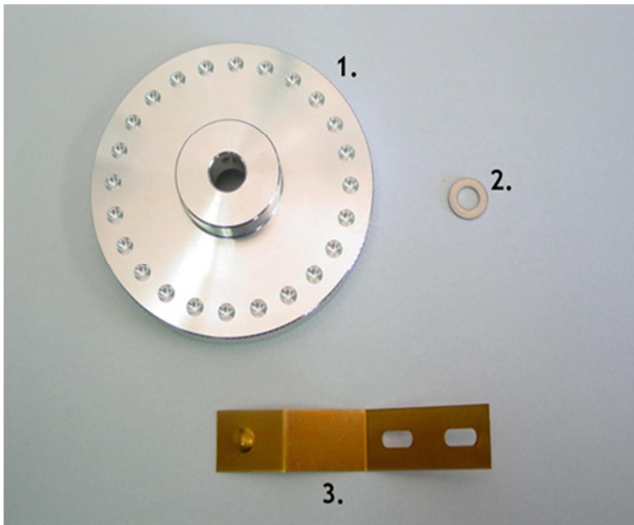

1. SP 005 218  
HANDWHEEL, SPLINED  
SCROLL SHAFT

2. SP 004 664  
SPACER, SCROLL SHAFT

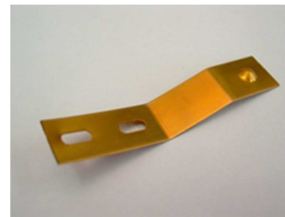

3. SP 003 436  
DETENT, SPRING

FEED MOTOR MOUNT ASSEMBLY SPARE PARTS



SP 000 280  
COVER, FEED MOTOR  
MOUNT



SP 001 262  
BUSH, TRANSTORQUE,  
LOCKING

INFEEED GUIDE ASSEMBLY SPARE PARTS

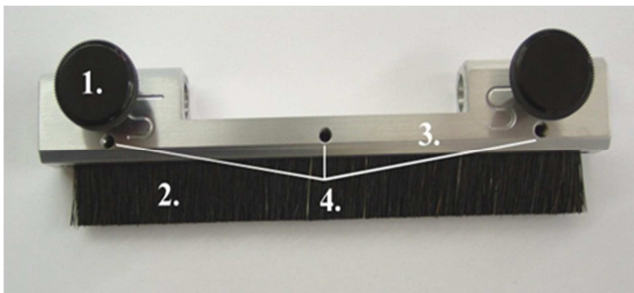

1. SP 000 318  
KNOB, KNURLED

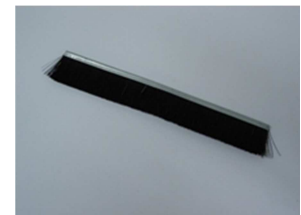

2. SP 006 527  
BRUSH, INFEEED GUIDE  
ASSEMBLY



3. SP 006 490  
MOUNT, INFEEED GUIDE  
ASSEMBLY



4. SP 000 046  
SCREW, M4 X 6MM,  
GRUB

INFEED GUIDE ASSEMBLY SPARE PARTS

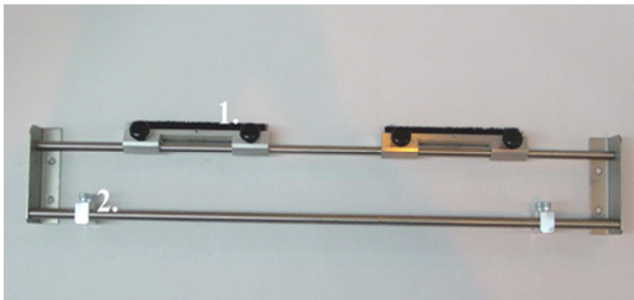

1. SP 006 526  
INFEED GUIDE BRUSH  
ASSEMBLY



2. SP 006 533  
INFEED PAPER GUIDE



1. SP 001 965  
SCREW, KNURLED



2. SP 006 491  
SLIDING PIECE,  
INFEED GUIDE

PRESSURE HEAD SPARE PARTS



1. SP 006 890  
CAP, PRESSURE  
RELEASE ARM



2. SP 007 012  
SCREW, NYLON  
TIPPED GRUB



3. SP 000 197  
SCREW, M6 X 16MM,  
COUNTERSUNK



4. SP 006 895  
PRELOAD ADJUSTING  
KNOB



5. SP 006 894  
PRESSURE HEAD  
RELEASE ARM



6. SP 006 888  
PIN, PRESSURE  
RELEASE



7. SP 006 892  
PRESSURE HEAD  
UPPER ASSEMBLY



8. SP 001 009  
SCREW, M4 X 16,  
SOCKET HEAD

PRESSURE HEAD SPARE PARTS



9. SP 005 879  
BUSH



10. SP 006 897  
SPRING, PRESSURE  
HEAD



11. SP 000 047  
SCREW, M4 x 4MM,  
GRUB



12. SP 006 886  
PLUG, NYLON



13. SP 006 885  
SCREW, NYLON TIP  
GRUB



14. SP 006 896  
AXLE, PRESSURE  
WHEEL



15. SP 000 378  
SCREW, M4 x 8, DOG  
POINT GRUB



16. SP 006 893  
PRESSURE HEAD  
LOWER ASSEMBLY



17. SP 004 703  
WASHER



18. SP 006 831  
PRESSURE ROLLER  
COMPLETE

PRESSURE HEAD MOUNTING BAR SPARE PARTS

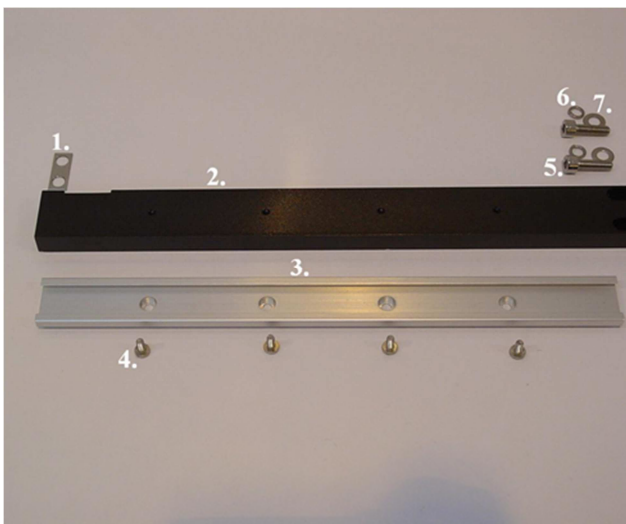

1. SP 006 948  
SHIM, MOUNT BAR,  
1MM



SP 006 944  
SHIM, MOUNT BAR,  
0.5MM



2. SP 006 943  
BAR, PRESSURE  
HEAD MOUNT



3. SP 006 945  
RAIL, LINEAR

PRESSURE HEAD MOUNTING BAR SPARE PARTS



4. SP 001 040  
SCREW, M4 x 8



5. SP 007 071  
SCREW,  
TAMPERPROOF



6. SP 004 440  
WASHER, M6 SPRING

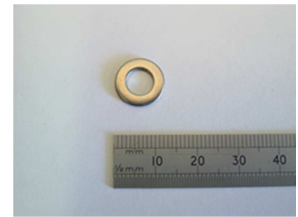

7. SP 000 650  
WASHER, M6,  
STANDARD

DRIVE ROLLER ASSEMBLY

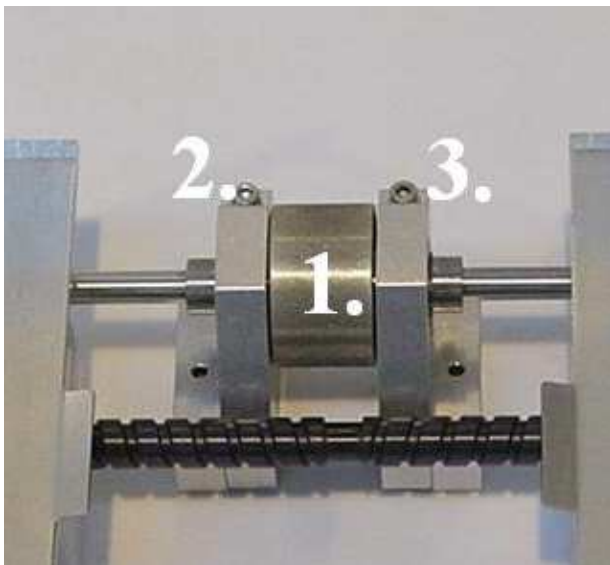

1. SP 006 869  
DRIVE ROLLER  
ASSEMBLY



2. SP 006 871  
DRIVE ROLLER  
MOUNT ASSEMBLY,  
LH



3. SP 006 870  
DRIVE ROLLER  
MOUNT ASSEMBLY,  
RH

DRIVE ROLLER MOUNT ASSEMBLY SPARE PARTS

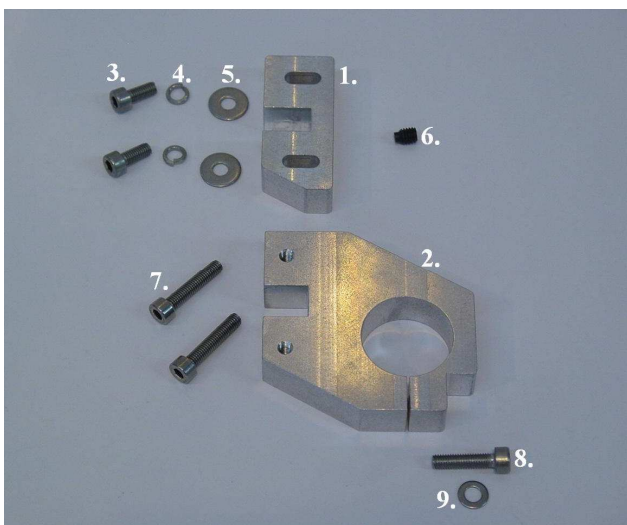

1. SP 006 868  
MOUNT, BEARING  
CLAMP, LH



SP 006 866  
MOUNT, BEARING  
CLAMP, RH



2. SP 006 867  
CLAMP, BEARING



3. SP 000 454  
SCREW, M5 x 12,  
SOCKET HEAD

DRIVE ROLLER MOUNT ASSEMBLY SPARE PARTS



4. SP 005 080  
WASHER, M5, SPRING

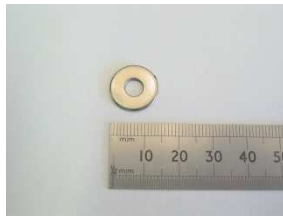

5. SP 005 081  
WASHER, M5, PLAIN



6. SP 000 889  
SCREW, M6 x 8, DOG  
POINT



7. SP 000 864  
SCREW, M5 x 25,  
SOCKET HEAD



8. SP 000 447  
SCREW, M5 x 20MM,  
SOCKET CAP



9. SP 000 711  
WASHER, M5 x  
12MM

ANTI-LIFT BAR ASSEMBLY

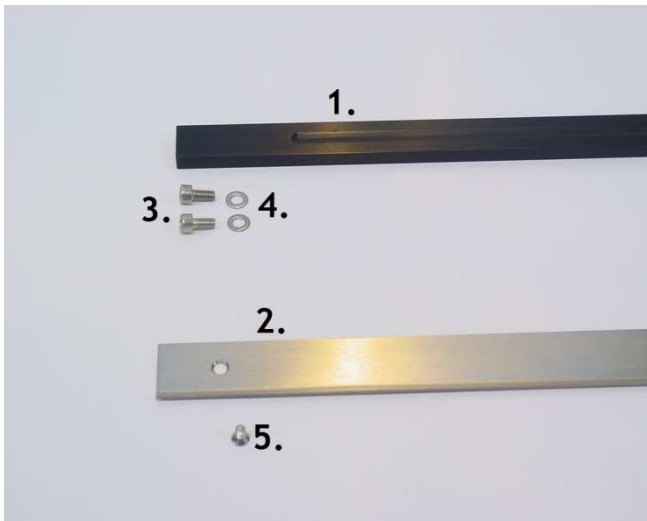

1. SP 006 899  
BAR, ANTI-LIFT



2. SP 006 900  
PLATE, GUIDE, ANTI-  
LIFT BAR



3. SP 000 037  
SCREW, M5 x 10,  
SOCKET CAP



4. SP 000 575  
WASHER, M5,  
STANDARD



5. SP 006 901  
SCREW, M4 x 6, CSK  
SOCKET CAP



SENSOR MOUNT ASSEMBLY

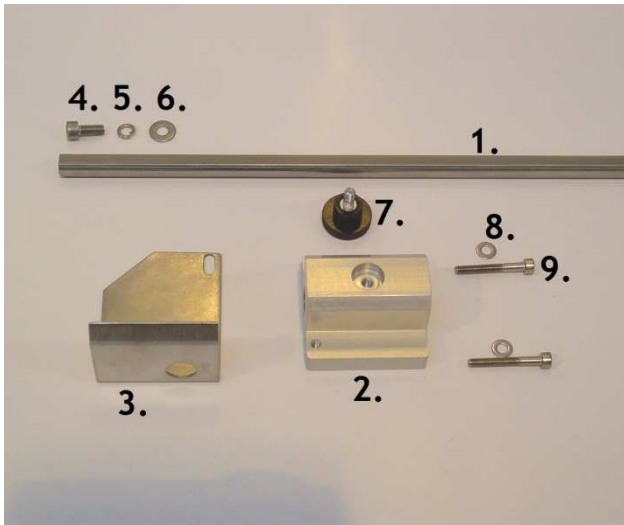

1. SP 006 778  
BAR, MOUNTING  
CROSS



2. SP 006 873  
MOUNT, SENSOR

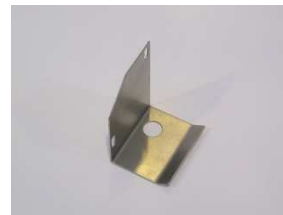

3. SP 006 951  
PLATE, SENSOR  
DEFLECTOR



4. SP 000 454  
SCREW, M5 x 12,  
SOCKET HEAD



5. SP 005 080  
WASHER, M5, SPRING



6. SP 000 575  
WASHER, M5, PLAIN



7. SP 000 318  
KNOB, M5 x 10MM



8. SP 000 622  
WASHER, M4, PLAIN



9. SP 000 842  
SCREW, M4 x 30,  
SOCKET HEAD

MARGIN TRIM BURSTER ASSEMBLY SPARE PARTS [OPTIONAL]



SP 006 670  
MARGIN TRIM BURSTER  
ASSEMBLY



SP 000 242  
ROLLER ASSEMBLY, MTB



SP 001 653  
BEARING, NEEDLE



SP 000 048  
BEARING, PRESSURE METAL  
ROLLER

MARGIN TRIM BURSTER ASSEMBLY SPARE PARTS [OPTIONAL]



SP 000 021  
BEARING, BURSTER ROLLER



SP 001 889  
BLADE, MTB

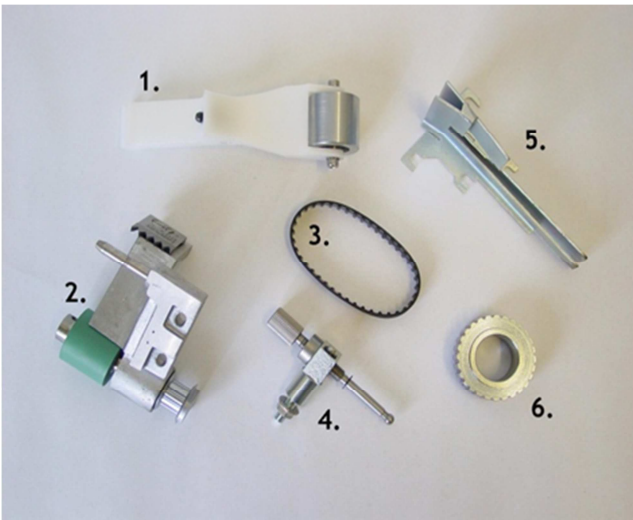

1. SP 003 066  
ROLLER, METAL  
PRESSURE, COMPLETE



SP 003 026  
CARRIER, PRESSURE  
ROLLER

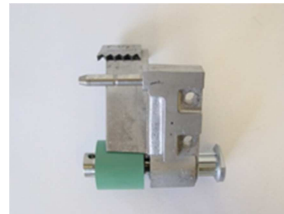

2. SP 005 124  
BURSTER SECTION  
COMPLETE



3. SP 000 061  
BELT, ROLLER DRIVE,  
NARROW



SP 001 970  
BELT, ROLLER DRIVE,  
WIDE



4. SP 005 125  
PRESSURE  
ACTUATOR



5. SP 006 668  
PAPER GUIDE, LH



SP 006 669  
PAPER GUIDE, RH



6. SP 003 030  
PULLEY, 28T, DMSA

BEARING PLATE COMPARTMENT SPARE PARTS



1. SP 004 499  
PULLEY, SMALL, E/T  
SHAFT

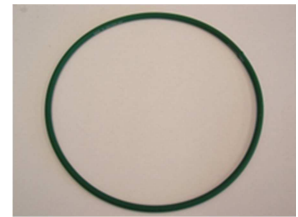

2. SP 004 474  
BELT, MAIN DRIVE, E/T



3. SP 004 498  
PULLEY, LARGE, E/T  
SHAFT

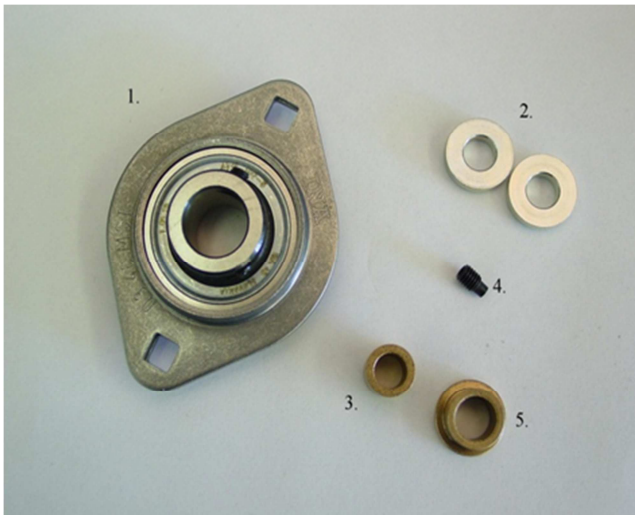

1. SP 002 133  
BEARING, E/T SHAFT

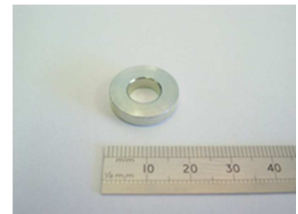

2. SP 004 465  
WASHER, BEARING  
PLATE LOCATING



3. SP 000 067  
BUSH, PAPER FEED  
SHAFT

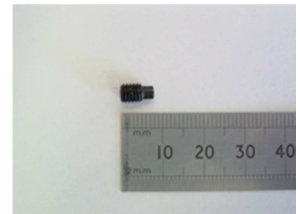

4. SP 000 869  
SCREW, GRUB



5. SP 000 092  
BUSH, OILITE, SCROLL  
SHAFT

PAPER OUTPUT

SP 004 708 - GANTRY ASSEMBLY

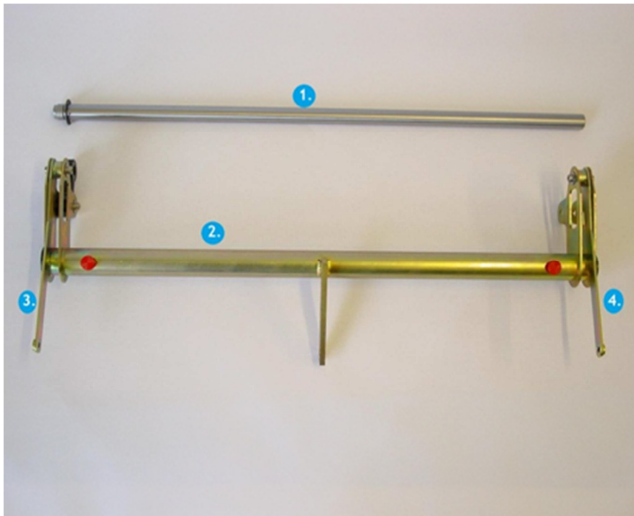

1. SP 004 651  
SHAFT, GANTRY

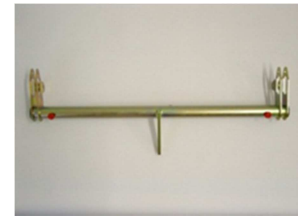

2. SP 004 707  
GANTRY TUBE  
ASSEMBLY W/O ARMS



3. SP 004 700  
GANTRY ARM, LH



4. SP 004 701  
GANTRY ARM, RH

GANTRY SHAFT SPARE PARTS



SP 004 652  
SCREW, SPECIAL M10



SP 004 653  
RING, SPECIAL M10



SP 004 811  
CIRCLIP, 15MM

GANTRY TUBE SPARE PARTS & GANTRY ARM SPARE PARTS



SP 004 688  
BUSH, GANTRY



SP 004 606  
GANTRY BUSH, OILITE



SP 005 311  
GANTRY DRAIN PLUG C/W  
SEAL



SP 004 607  
GANTRY OIL SEAL



SP 005 426  
GANTRY OIL



SP 004 578  
GANTRY CONROD C/W  
BEARING

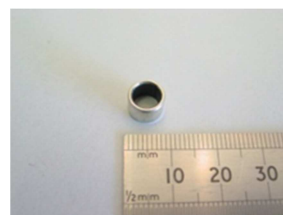

SP 000 175  
GANTRY ARM BUSH



SP 004 513  
GANTRY ARM BUSH, LARGE

BLADE ASSEMBLY

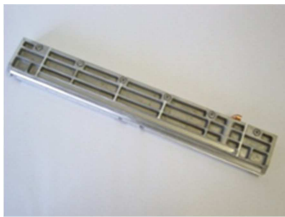

SP 004 539  
BLADE GUIDE ASSEMBLY

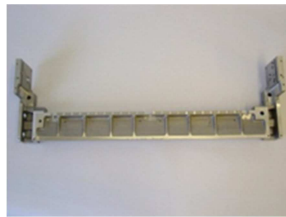

SP 004 449  
BLADE SUPPORT, LOWER

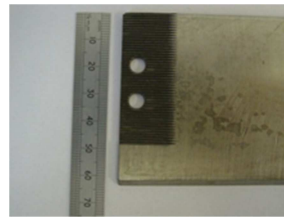

SP 000 803  
45° NARROW TOP CROSS  
CUT BLADE



SP 000 066  
LOWER CROSS CUT  
BLADE



SP 005 242  
PLATE, BLADE MOUNT



SP 000 234  
GUARD, LOWER CROSS CUT  
BLADE



SP 001 055  
BLADE MOUNT, LH



SP 001 056  
BLADE MOUNT, RH

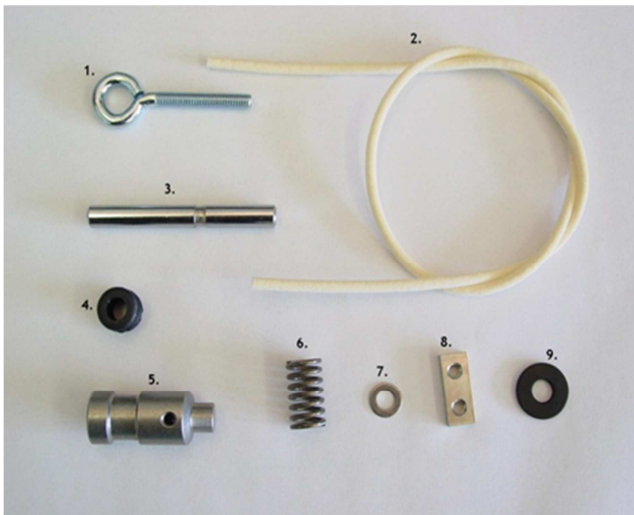

1. SP 002 034  
SCREW, EYE



2. SP 000 181  
BLADE FELT



3. SP 000 058  
SHAFT, BLADE GUIDE



4. SP 000 919  
GROMMET, RUBBER



5. SP 001 351  
BOLT, ECCENTRIC



6. SP 001 817  
SPRING, BLADE  
TENSION



7. SP 000 575  
WASHER, M5



8. SP 000 481  
PLATE, BACKSTOP



9. SP 004 602  
SPACER, BLADE



SP 007 019  
DEFLECTOR PLATE

BLADE GUIDE SPARE PARTS

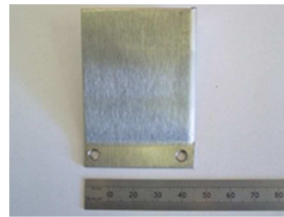

1. SP 004 678  
GUARD, GANTRY  
ARM, LH

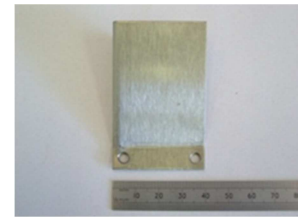

2. SP 004 679  
GUARD, GANTRY ARM,  
RH



3. SP 004 728  
PLATE, STRIP CUT



4. SP 006 921  
THUMBWHEEL  
ASSEMBLY



5. SP 006 917  
UPPER BLADE GUIDE

ROLLER BLADE STOP SPARE PARTS

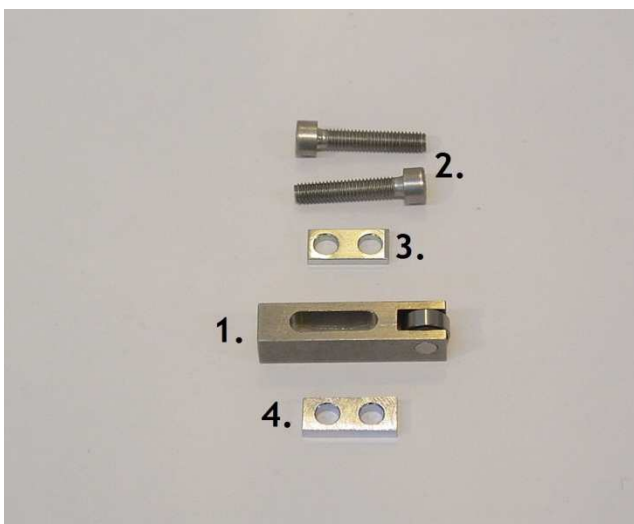

1. SP 005 369  
ROLLER BLADE STOP  
ASSEMBLY



2. SP 000 885  
SCREW, M6 x 30,  
SOCKET CAP



3. SP 000 481  
PLATE, 6MM CLAMP

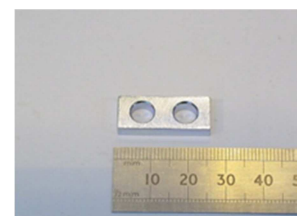

4. SP 006 940  
PLATE, 4MM SPACER

STACK TRAY ASSEMBLY

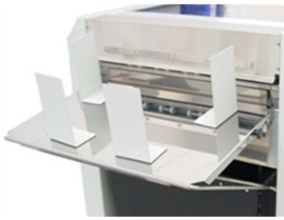

SP 000 416  
STACK TRAY ASSEMBLY

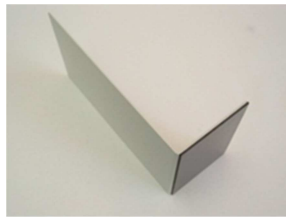

SP 000 103  
STACK TRAY MAGNETIC  
GUIDE

KICKOUT ROLLER ASSEMBLY

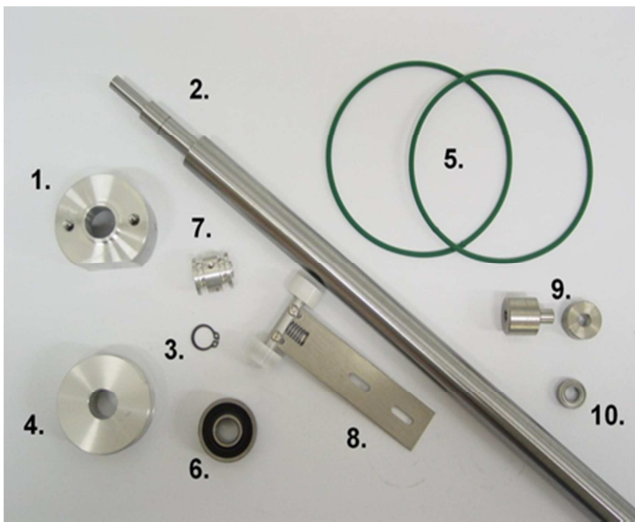

1. SP 004 666  
HOUSING, KICKOUT  
ROLLER BEARING



2. SP 004 773  
SHAFT, KICKOUT  
ROLLER



3. SP 001 422  
CIRCLIP, 12MM,  
EXTERNAL



4. SP 004 672  
PULLEY, DRIVE



5. SP 001 957  
BELT, KICKOUT DRIVE



6. SP 004 670  
PULLEY, DRIVEN,  
KICKOUT ROLLER



7. SP 004 716  
BEARING, KICKOUT  
ROLLER



8. SP 006 924  
PRESSURE WHEEL  
ASSEMBLY COMPLETE



9. SP 004 667  
AXLE, KICKOUT  
ROLLER SPACER



10. SP 004 583  
BEARING, KICKOUT  
ROLLER SHAFT

AIR BLAST PUMP ASSEMBLY

---



SP 004 656  
AIR BLAST PUMP ASSEMBLY



SP 001 057  
BELLOWS



SP 004 691  
PUMP HOUSING COMPLETE



SP 004 683  
LID, AIR PUMP

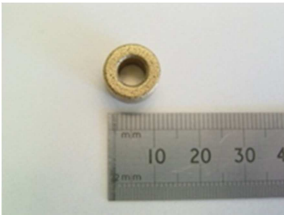

SP 000 110  
BUSH, PUMP BELLOWS



SP 002 230  
DISC, AIR PUMP SEAL



SP 001 322  
HOSE, AIR PUMP